

Franco Maloberti

Layout of Analog CMOS

Integrated Circuit

Part 3

Passive components: Resistors, Capacitors

Outline

- ❖ Introduction
- ❖ Process and Overview Topics
- ❖ Transistors and Basic Cells Layout
- ❖ Passive components: Resistors, Capacitors
- ❖ System level Mixed-signal Layout

Integrated Capacitors

Capacitors in IC are parallel plate capacitors

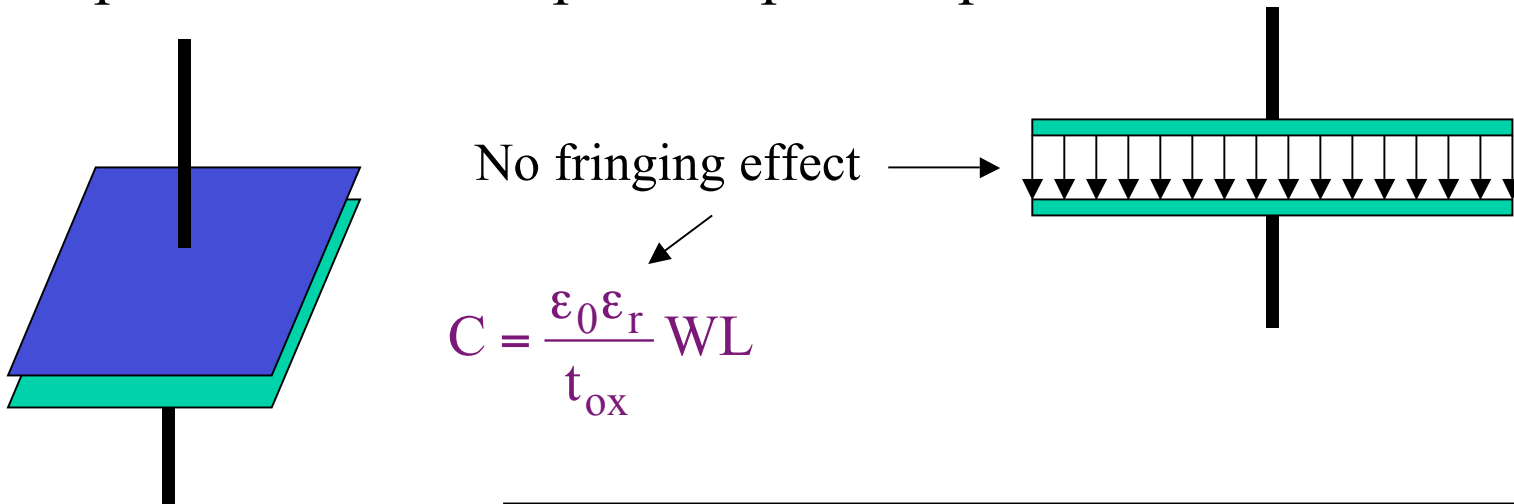

Material	Rel. Permittivity	Diel. Strength
SiO ₂ Dry Oxide	3.9	11 V/nm
SiO ₂ Plasma	4.9	3-6 V/nm
Si ₃ N ₄ LPCVD	6-7	10 V/nm
Si ₃ N ₄ Plasma	6-9	5 V/nm

Types of Integrated Capacitors

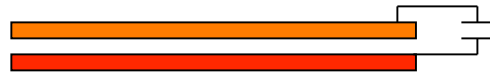

Poly-poly

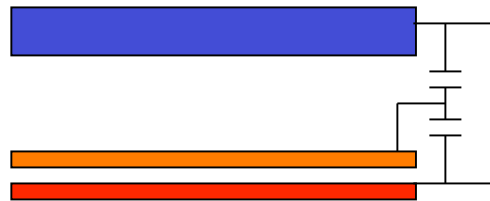

Sandwich



Lateral plates
(flux capacitor)

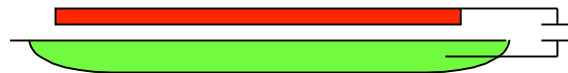

Poly- diffusion

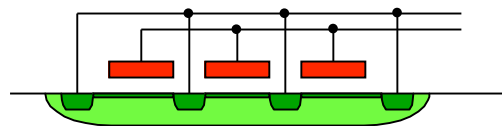

Poly-channel

Features of Integrated Capacitors

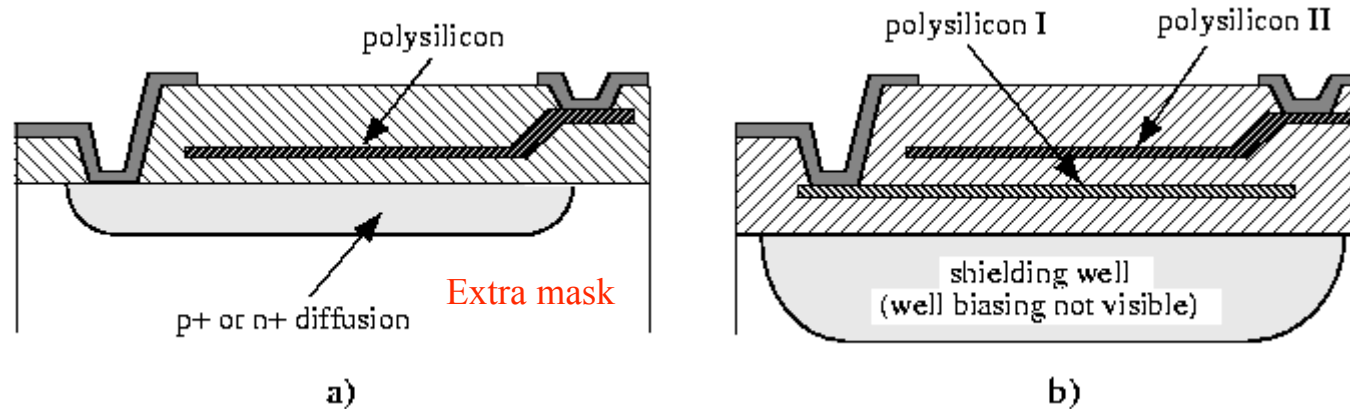

Electrodes : metal; polysilicon; diffusion

Insulator : silicon oxide; polysilicon oxide; CVD oxide

$$C = \frac{\epsilon_0 \epsilon_r}{t_{ox}} WL$$

$$\left(\frac{\Delta C}{C}\right)^2 = \left(\frac{\Delta \epsilon_r}{\epsilon_r}\right)^2 + \left(\frac{\Delta t_{ox}}{t_{ox}}\right)^2 + \left(\frac{\Delta L}{L}\right)^2 + \left(\frac{\Delta W}{W}\right)^2$$

F. Maloberti - *Layout of Analog CMOS IC*

Factor affecting accuracy

$$\left(\frac{\Delta \epsilon_r}{\epsilon_r} \right)$$

- Oxide damage
- Impurities
- Bias condition
- Bias history (for CVD)
- Stress
- Temperature

$$\left(\frac{\Delta t_{\text{ox}}}{t_{\text{ox}}} \right)$$

- Grow rate
- Poly grain size

$$\left(\frac{\Delta L}{L} \right); \left(\frac{\Delta W}{W} \right)$$

- Etching
- Alignment

Layout of Capacitors

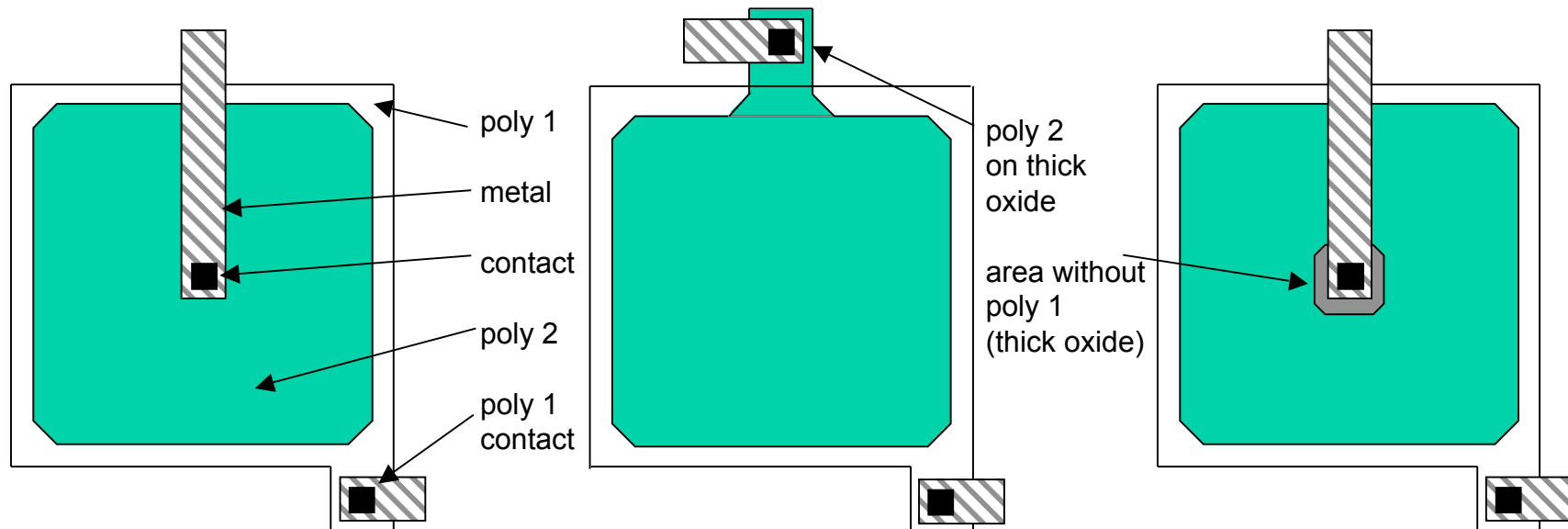

To achieve good matching :

- Use of unity capacitors connected in parallel
- Use $W = L$ fairly large

F. Maloberti - *Layout of Analog CMOS IC*

Flux Capacitor Layout

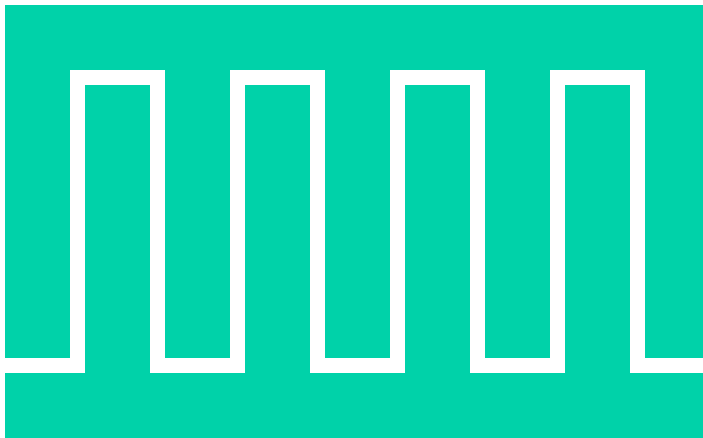

- ❖ Use of the same metal layer
- ❖ Exploit the lateral flux
- ❖ The parasitic capacitance plate -substrate is low because the metal sits on thick oxide
- ❖ Use thick metal layers
- ❖ Maximize the perimeter (use of fractals)
- ❖ Very good matching!

Common Centroid Structures

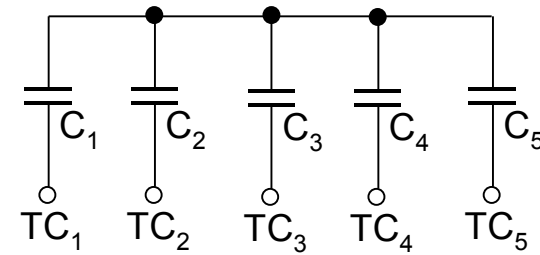
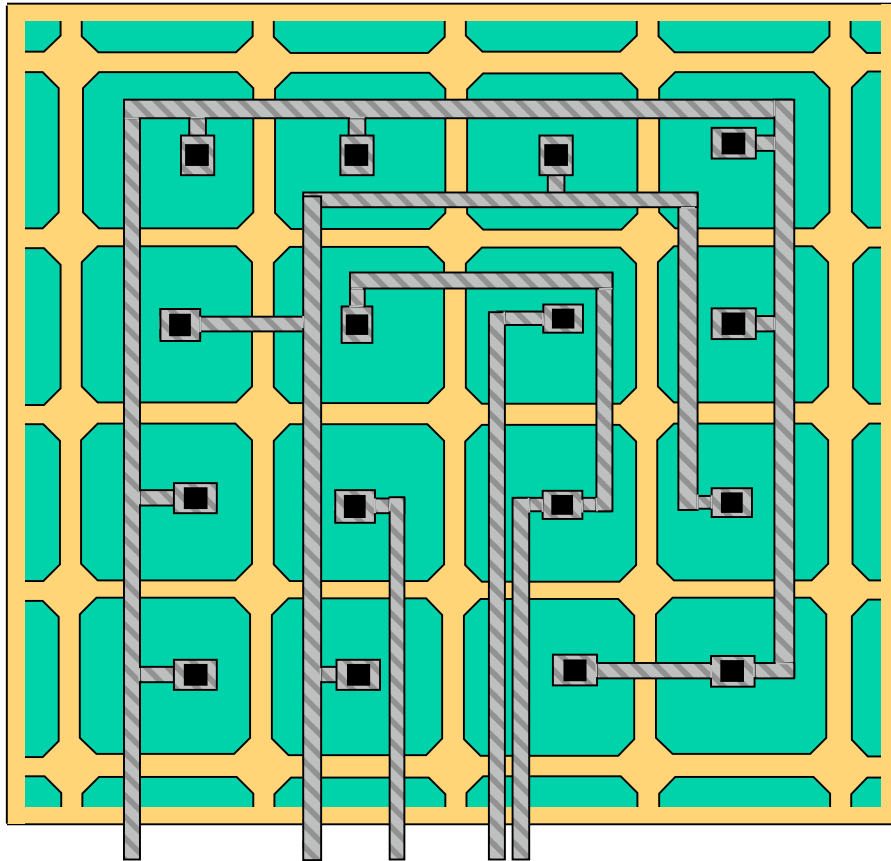

$$\begin{aligned} C_2 &= C_1 \\ C_3 &= 2C_1 \\ C_4 &= 4C_1 \\ C_5 &= 8C_1 \end{aligned}$$

F. Maloberti - *Layout of Analog CMOS IC*

Matching of Capacitors

Matching accuracy is better than matched resistors, because :

- $\left(\frac{\Delta\varepsilon_r}{\varepsilon_r}\right) \ll \left(\frac{\Delta\rho}{\rho}\right)$
- $\left(\frac{\Delta W}{W}\right)_{\text{cap}} < \left(\frac{\Delta W}{W}\right)_{\text{res}}$ (because the capacitors are square)
- $\left(\frac{\Delta t_{\text{ox}}}{t_{\text{ox}}}\right) < \left(\frac{\Delta x_j}{x_j}\right)$

Undercut Effect

$$W' = W - 2x$$

$$L' = L - 2x$$

Effective area :

$$A' = W'L' = WL - 2(L + W)x$$

$$A' = A - Px$$

The undercut effect gives the same proportional reduction if the perimeter-area ratio is kept constant

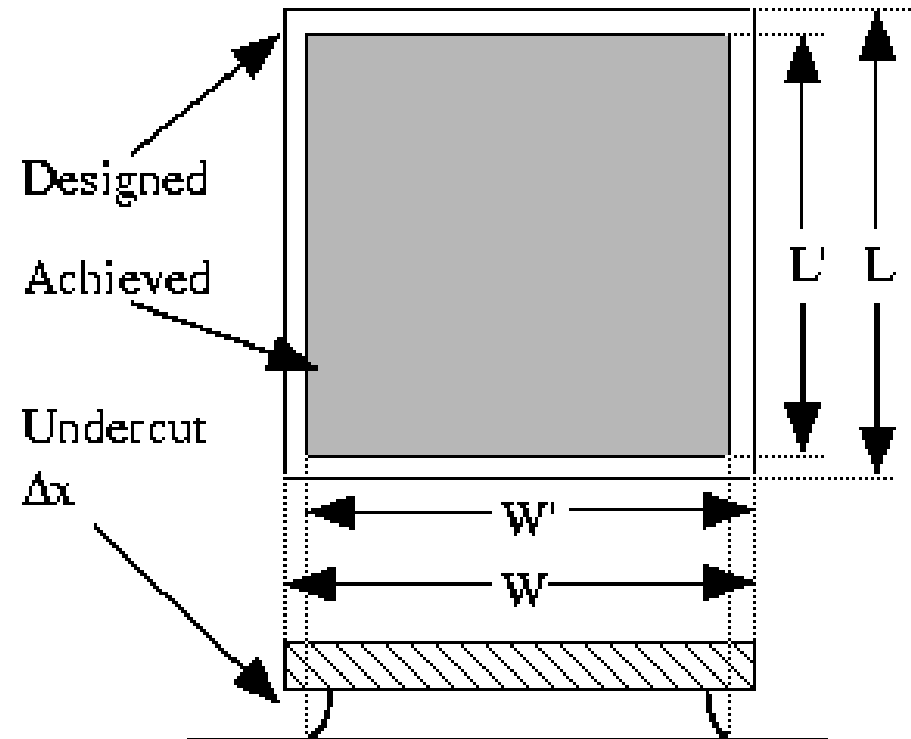

Matched Capacitors: Exercise

❖ Layout the following three capacitors

★ $C_1 = 0.95 \text{ pF}$

★ $C_2 = 1.24 \text{ pF}$

★ $C_3 = 1.37 \text{ pF}$

★ The absolute accuracy is not important. What matter is the capacitance ratios.

Fringing Effect

❖ Equation $C = \frac{\epsilon_0 \epsilon_r}{t_{ox}} WL$ is an approximation

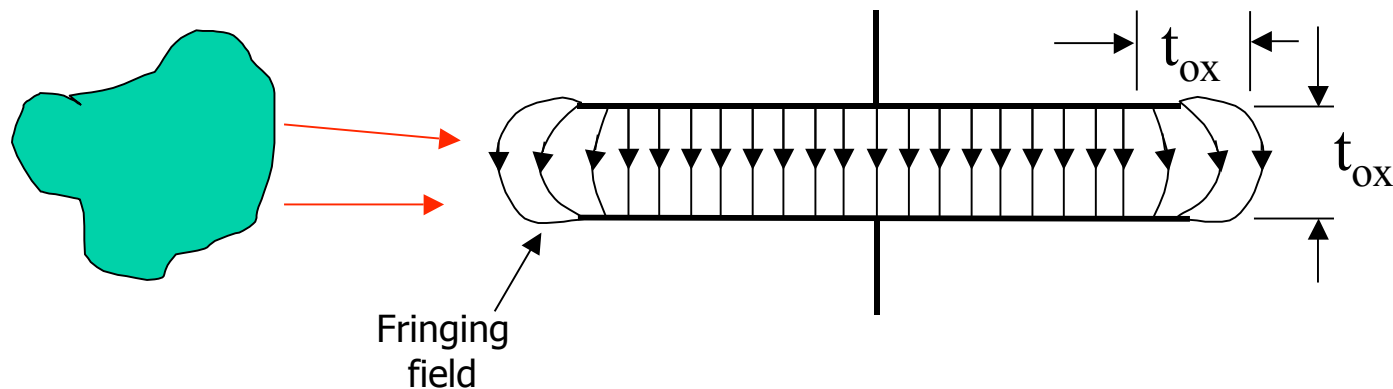

$$C = \frac{\epsilon_0 \epsilon_r}{t_{ox}} (W - t_{ox})(L - t_{ox}) + C_{fring}$$

❖ Fringing depends on the boundary conditions

MOS Capacitors Features

Type	t_{ox} nm	Accuracy %	Temperature Coefficient ppm/°C	Voltage Coefficient ppm/V
poly - diff.	15 - 20	7 - 14	20 - 50	60 - 300
poly I - poly II	15 - 25	6 - 12	20 - 50	40 - 200
metal - poly	500 - 700	6 - 12	50 - 100	40 - 200
metal - diff.	1200 - 1400	6 - 12	50 - 100	60 - 300
metal I - metal II	800 - 1200	6 - 12	50 - 100	40 - 200

Parasitic Capacitances

	diffusion	poly-poly or poly-metal
$C_{p,b}$	$0.05C$	$0.02 C$
$C_{p,t}$	$0.01C$	$0.005 C$

High impedance node connected to the top plate

Poly-poly capacitor

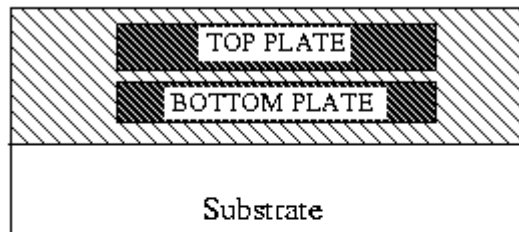

Poly-diffusion capacitor

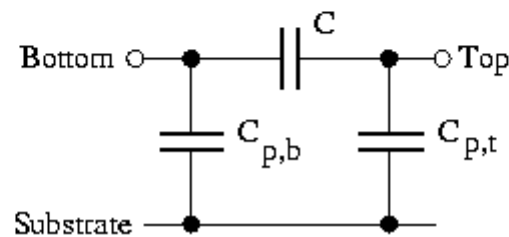
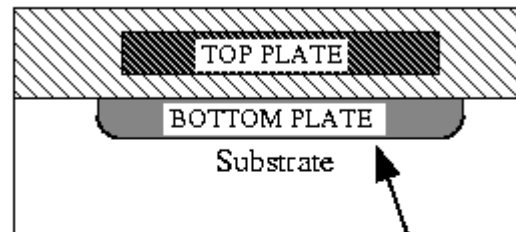

Reversely biased junction

Rules for Capacitor Matching

- ❖ Use identical geometries
- ❖ Use large unity capacitance (minimize fringing)
- ❖ Use common centroid arrangement
- ❖ Use dummy capacitors
- ❖ Use shielding
- ❖ Account for the connections' contribution
- ❖ Don't run connections over capacitor
- ❖ Place capacitor in low stress areas
- ❖ Place capacitors far from power devices

Integrated Capacitors

❖ Issues to remember

- ★ Use unit capacitors
- ★ Make bigger capacitors integer multiples of the unit capacitor
- ★ Use common centroid layout to match capacitors
- ★ Use multiple contacts to lower series resistance

Integrated Resistor Cross-section

- ❖ A resistor is made of a strip of resistive layer.

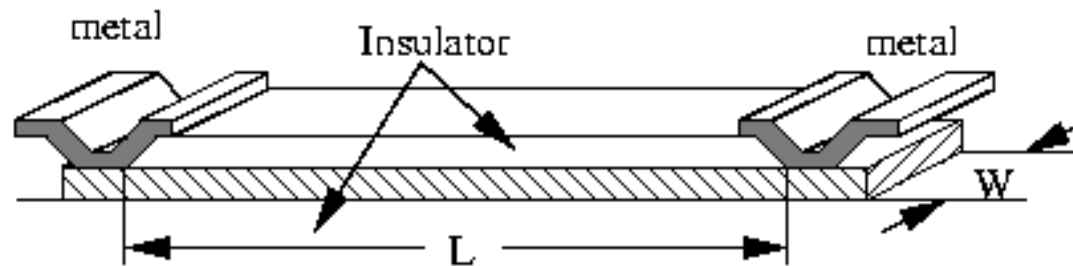

$$R = 2R_{\text{cont}} + \frac{L}{W} R_{\square}$$

- ❖ The endings resistance can be significant!

Diffused Resistances

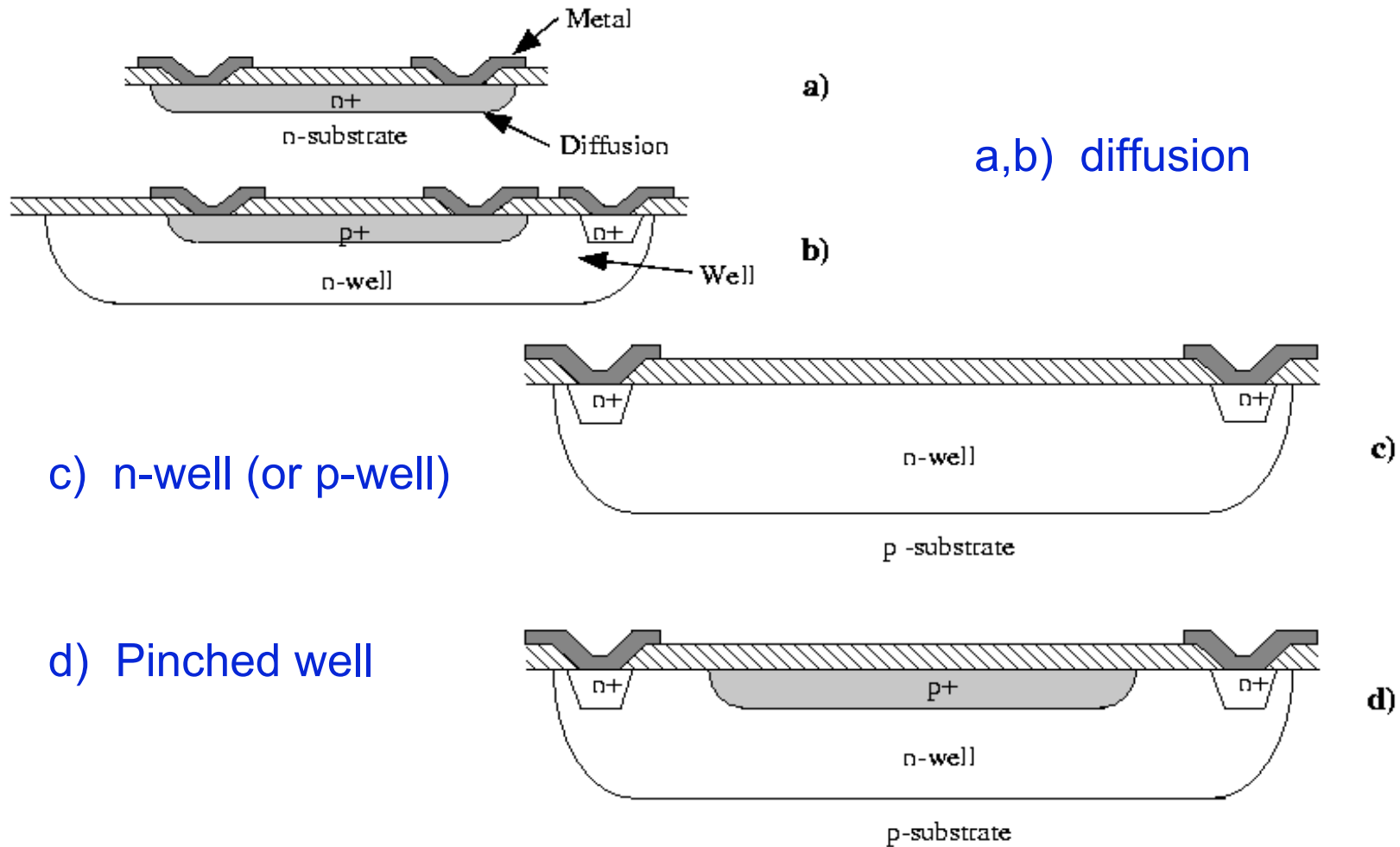

Polysilicon Resistances

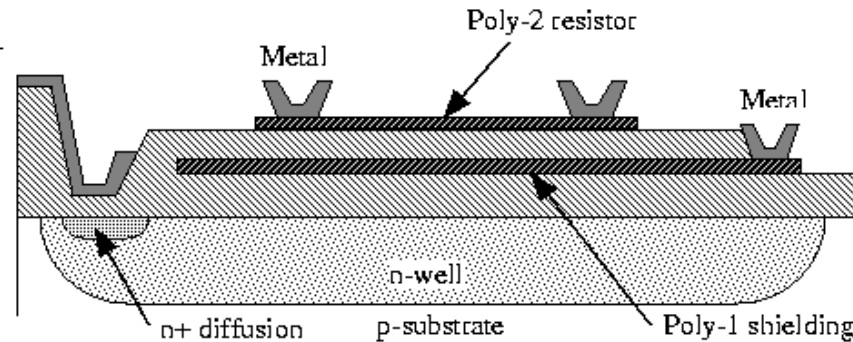
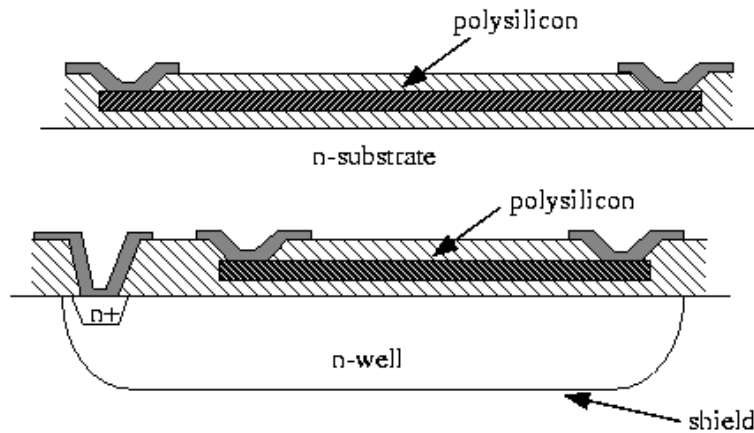

Conductive layers can be used to shield the conductor-oxide-conductor structure

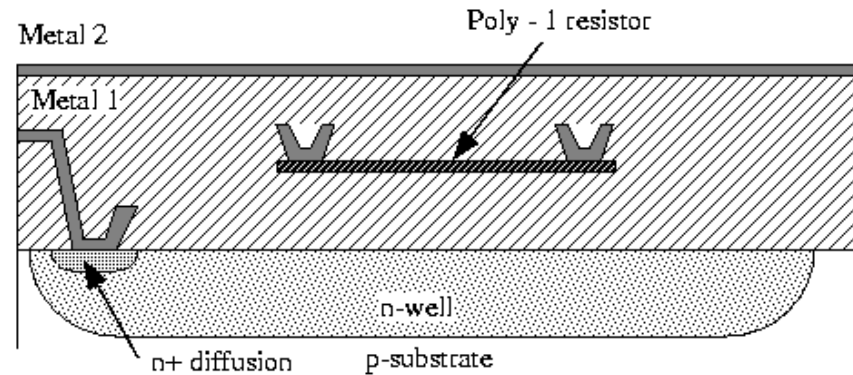

Well or Pinched-well Resistors

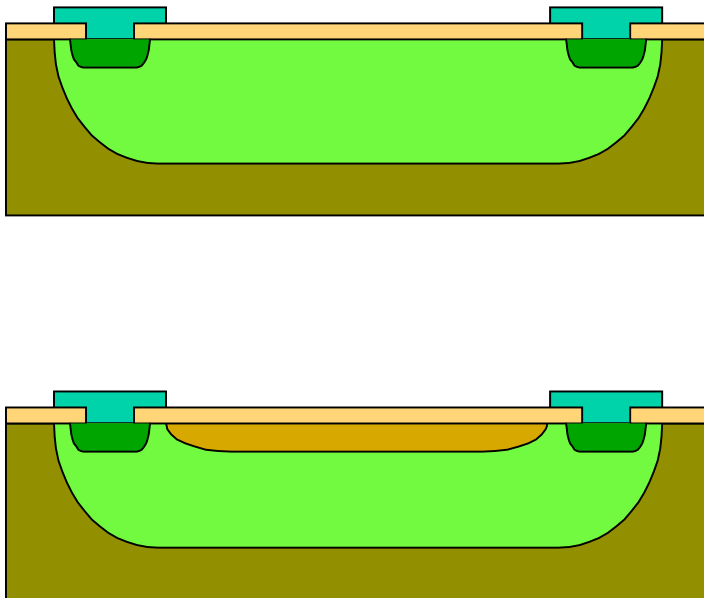

- Well layers have a large specific resistance
- but
- They have a large voltage and temperature coefficient
- They are weakly insulated from the surrounding
- Layers close to the surface contribute to the conductivity

Large Value Resistors

In order to have large value resistors :

- Use of long strips (large L/W)
- Use of layers with high sheet resistance (bad performances)

Layout : rectangular “snake”

(!!)

Resistance at the corners

Current flows in different directions

DON'T USE IT IN PRECISE APPLICATIONS!

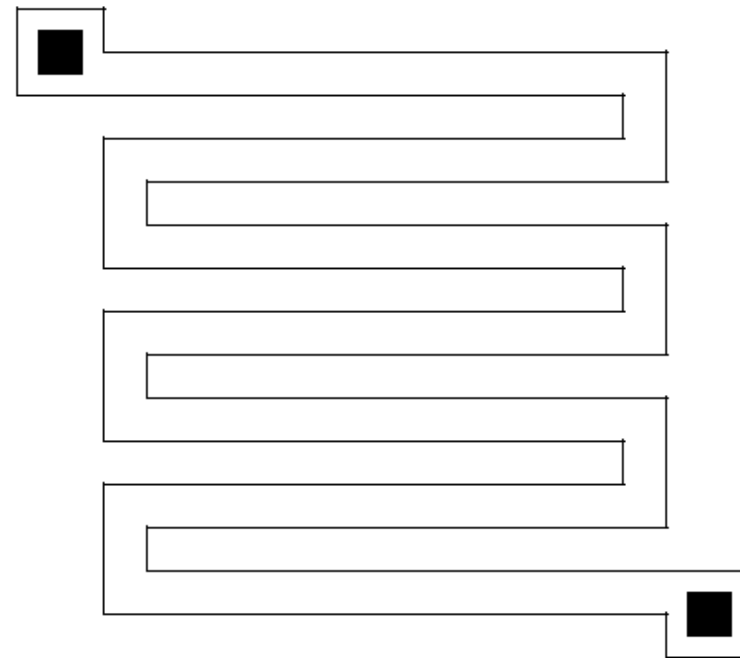

Prevent Current Leakage!

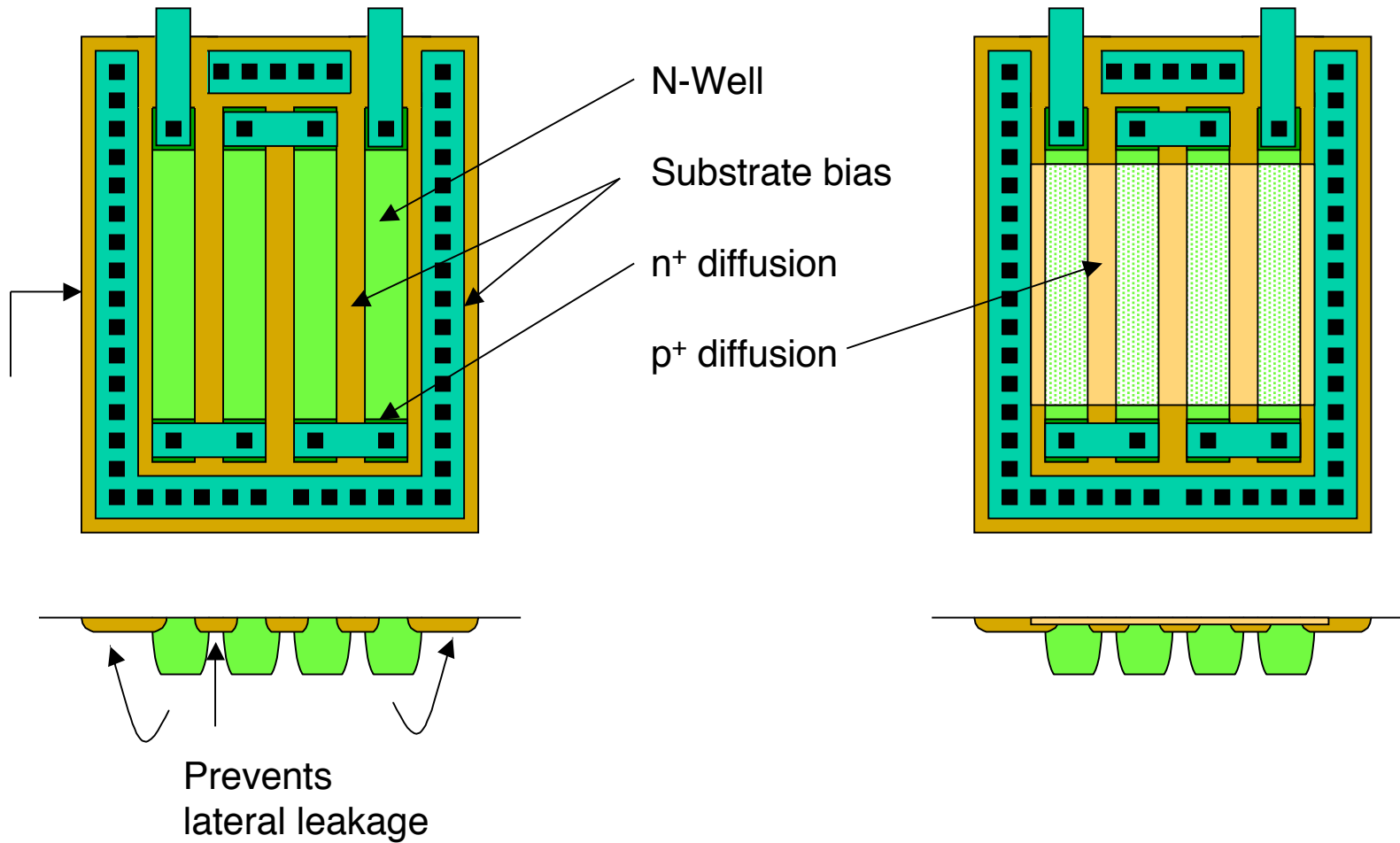

F. Maloberti - *Layout of Analog CMOS IC*

Features of Resistors

Type of layer	Sheet Resistance Ω/\square	Accuracy %	Temperature Coefficient ppm/ $^{\circ}\text{C}$	Voltage Coefficient ppm/V
n + diff	30 - 50	20 - 40	200 - 1K	50 - 300
p + diff	50 - 150	20 - 40	200 - 1K	50 - 300
n - well	2K - 4K	15 - 30	5K	10K
p - well	3K - 6K	15 - 30	5K	10K
pinched n - well	6K - 10K	25 - 40	10K	20K
pinched p - well	9K - 13K	25 - 40	10K	20K
first poly	20 - 40	25 - 40	500 - 1500	20 - 200
second poly	15 - 40	25 - 40	500 - 1500	20 - 200

F. Maloberti - *Layout of Analog CMOS IC*

Resistor's Accuracy

$$R = \frac{L}{W} R_{\square} = \frac{L}{W} \cdot \frac{\bar{\rho}}{x_j}$$

If the parameter are statistically independent the standard deviation of the resistance is :

$$\left(\frac{\Delta R}{R}\right)^2 = \left(\frac{\Delta L}{L}\right)^2 + \left(\frac{\Delta W}{W}\right)^2 + \left(\frac{\Delta \bar{\rho}}{\bar{\rho}}\right)^2 + \left(\frac{\Delta x_j}{x_j}\right)^2$$

$$\left(\frac{\Delta L}{L}\right) \ll \left(\frac{\Delta W}{W}\right)$$

Since in general $L \gg W$

Resistor's Accuracy (cont.)

$\left(\frac{\overline{\Delta\rho}}{\overline{\rho}} \right)$ for polysilicon resistors is larger than for diffused resistors.

(Polysilicon is composed of a conglomerate of independently oriented grain of crystalline silicon)

Accuracy :

Absolute accuracy is poor because of the large parameter drift

Ratio (or matching) accuracy is better because it depends on the local variation of parameters.

Factor Affecting Accuracy

$$\left(\frac{\Delta \bar{\rho}}{\bar{\rho}} \right)$$

- Polysilicon grain size
- Doping dose
- Crystal defects
- Stress
- Temperature

$$\left(\frac{\Delta x_j}{x_j} \right)$$

- Implant dose
- Side diffusivity
- Deposition rate

$$\left(\frac{\Delta L}{L} \right); \left(\frac{\Delta W}{W} \right)$$

- Etching
- Boundary
- Side diffusivity

Other Elements

Plastic packages cause a large pressure on the die (= 800 Atm.). It determines a variation of the resistivity.

For $\langle 100 \rangle$ material the variation is unisotropic, so the minimum is get if the resistance have a 45° orientation.

Temperature :

Temperature gradient on the chip may produce thermal induced mismatch.

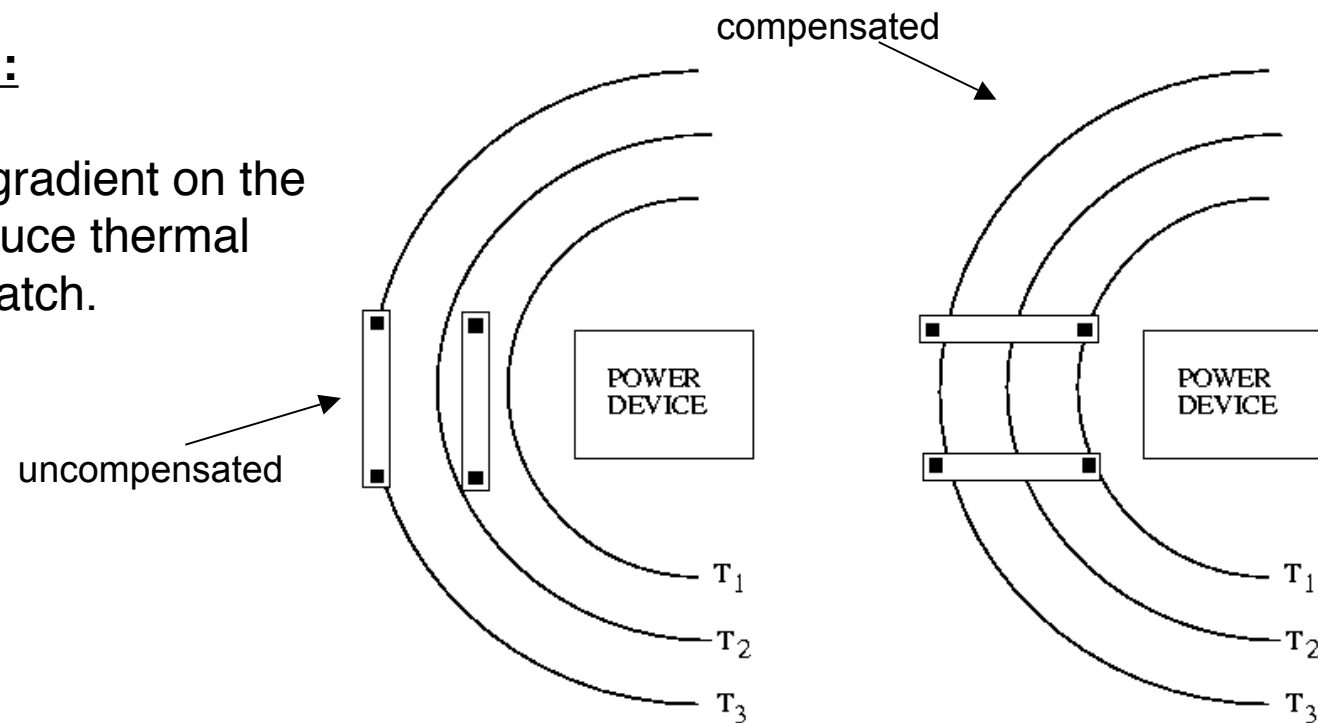

F. Maloberti - *Layout of Analog CMOS IC*

Effect of Etching

Wet etching : isotropic (undercut effect)

H_F for SiO_2 ; H_3PO_4 for Al

Δx for polysilicon may be 0.35 - 0.5 μ with standard deviation 0.02 μ .

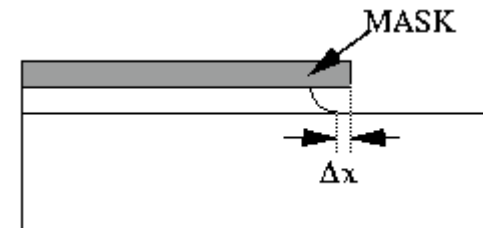

Reactive ion etching (R.I.E.)(plasma etching associated to “bombardment”) : unisotropic.

Δx for polysilicon is 0.2 μ with standard deviation 0.015 μ

Boundary :

The etching depends on the boundary conditions

Use of dummy strips

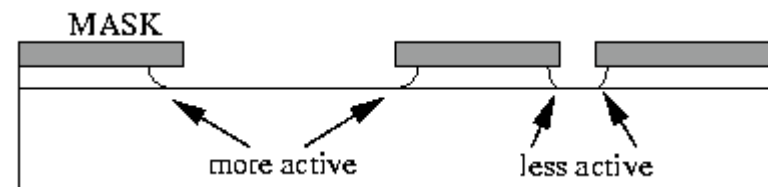

Side Diffusion

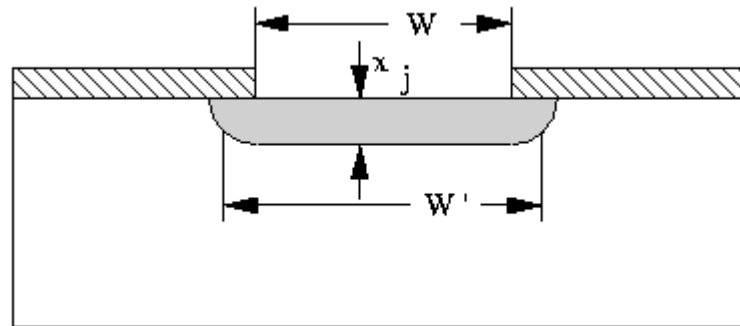

Contribution of Endings

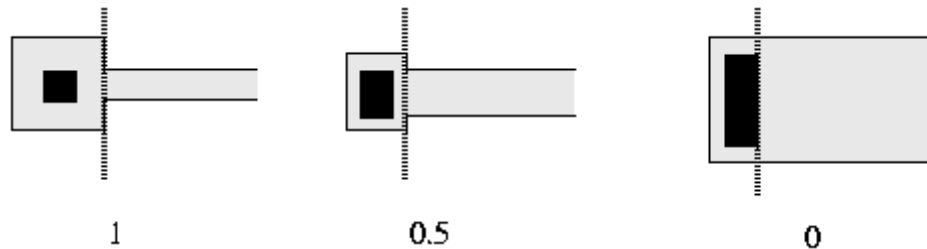

Interdigitized and Common Centroid

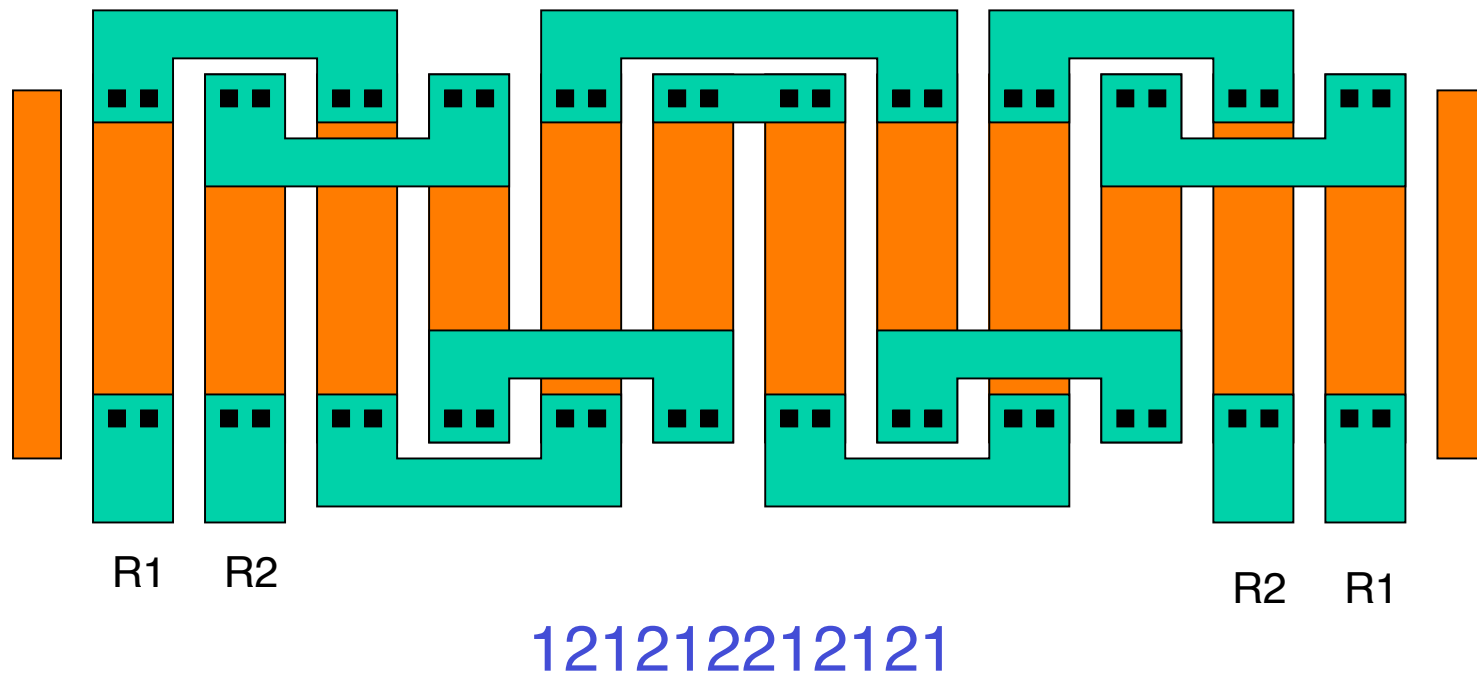

Exercise: draw a 121212121212 connection and compare the two solutions
Exercise: draw a common centroid structure (12 elements per resistor)

Resistor Guidelines

For matching :

- Use of equal structures
- Not too narrow ($W = 10 \text{ mm}$)
- Interdigitize
- Thermal effect compensation
- 45° orientation (if stressed)

For good TC :

- Use of n+ or p+ layers
- Use of poly layers

For absolute value :

- Use of diffused layers
- Suitable endings

Simple Model

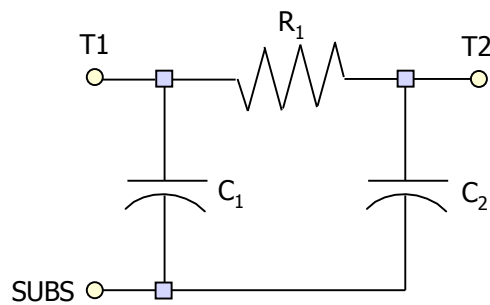
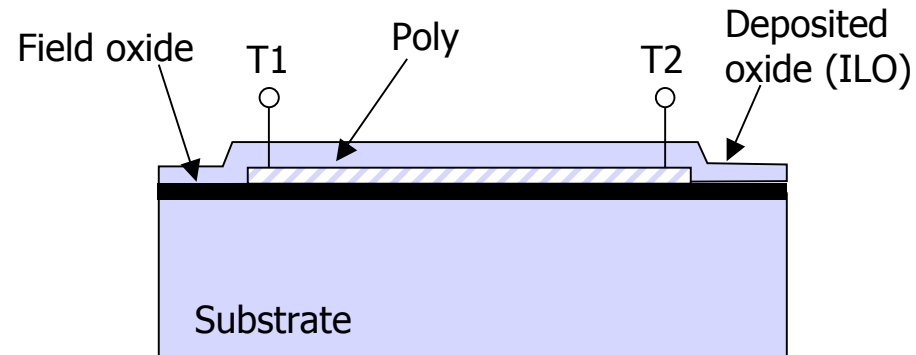

(A)

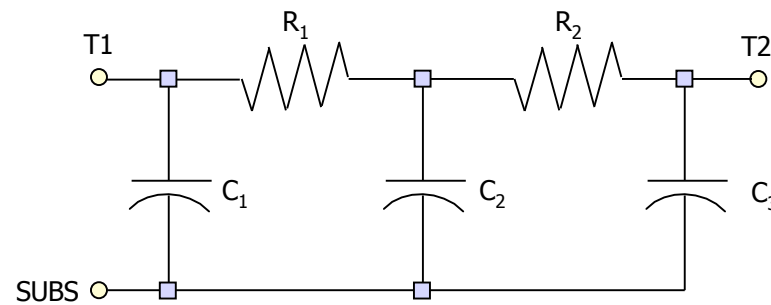

(B)

Metal Resistors

The sheet resistance of Al metallization is around $100 \text{ m}\Omega/\square$

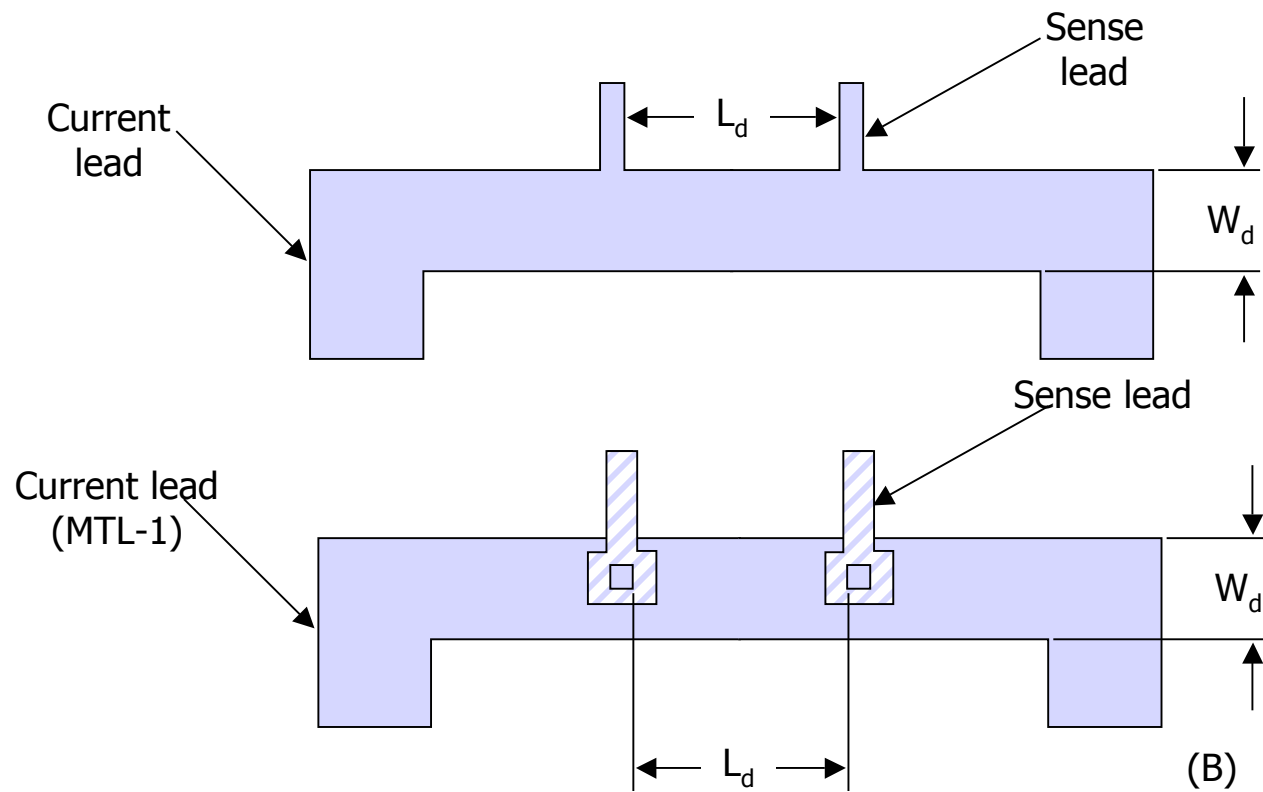

F. Maloberti - *Layout of Analog CMOS IC*

Adjusting Resistor Values

Sliding contact:
requires to change the
contact mask only

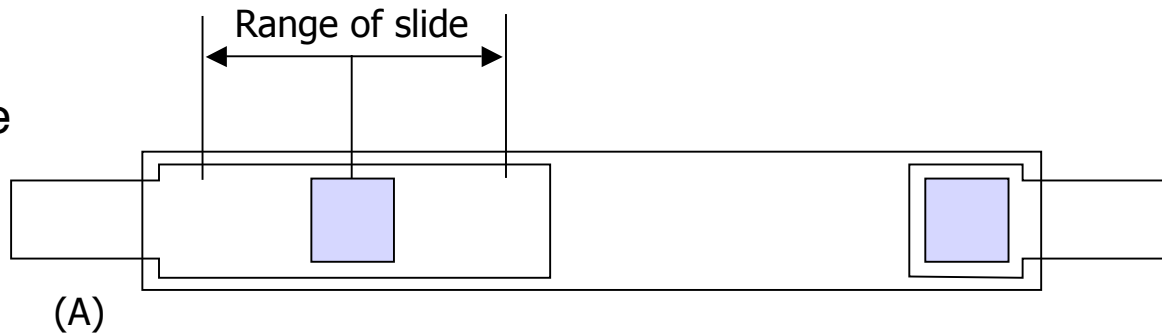

Metal fuse
and
Poly-fuse

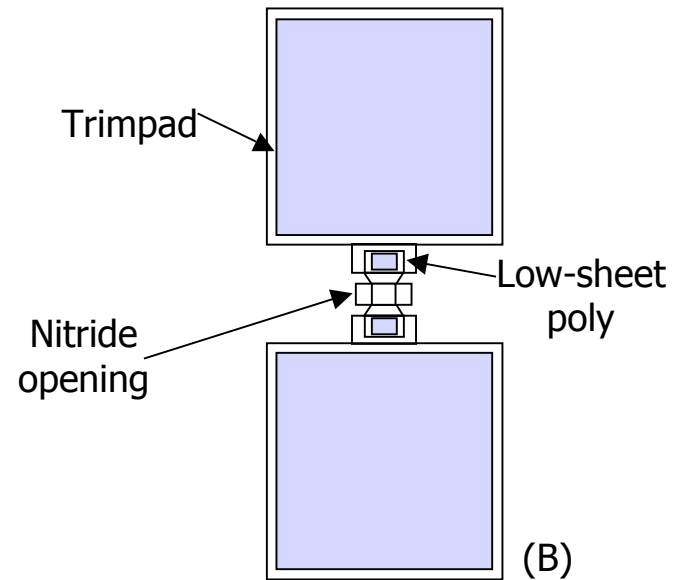
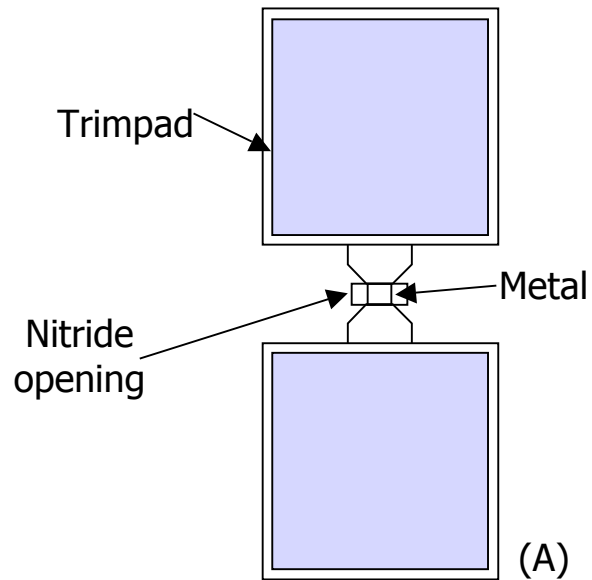

Use of Fuses To Adjust Resistors

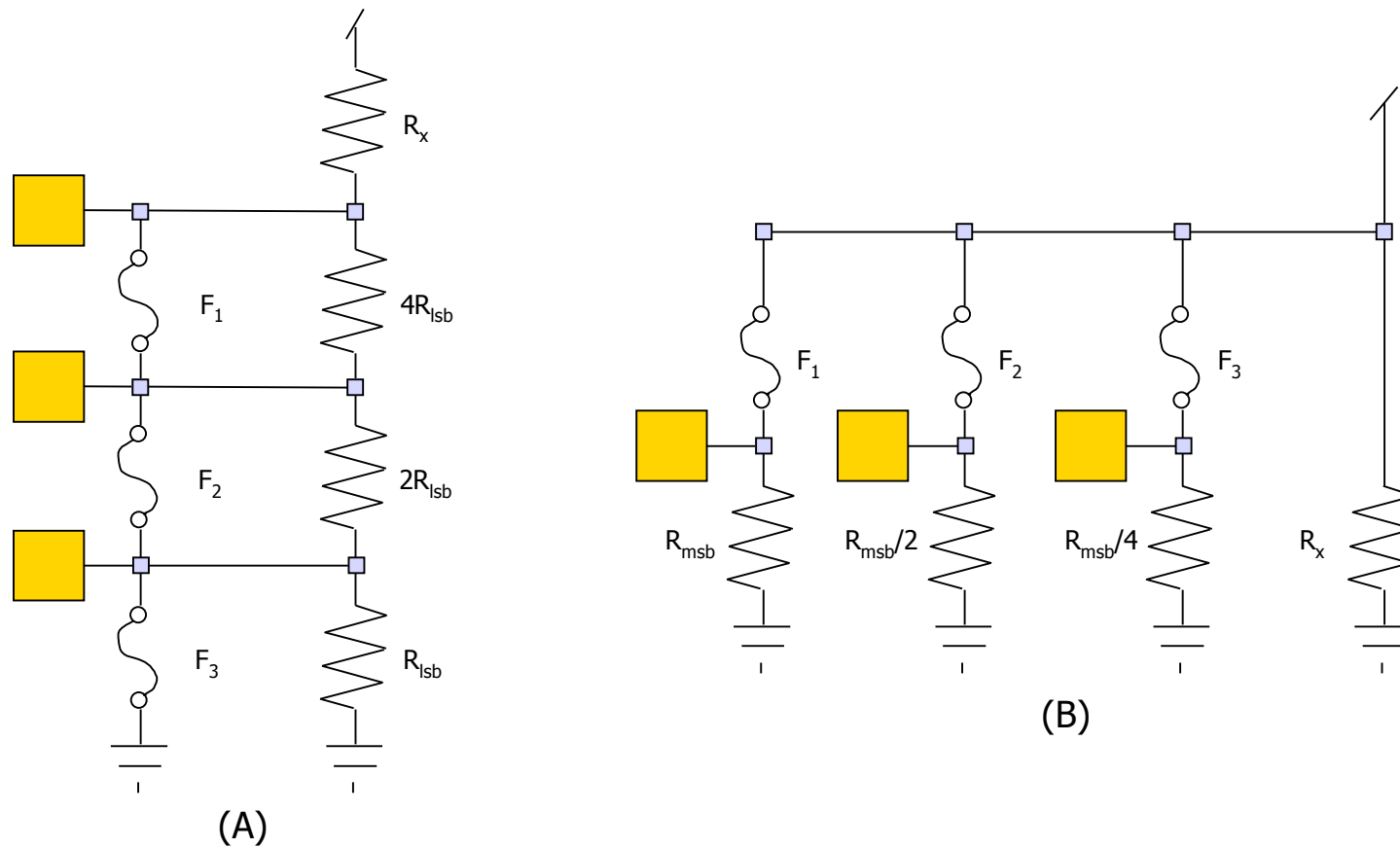

Rules for Resistor Matching

- ❖ Use the same material
- ❖ Identical geometry, same orientation
- ❖ Close proximity
- ❖ Interdigitate arrayed resistors
- ❖ Use dummy elements
- ❖ Place resistors in low stress area
- ❖ Place resistors away from power devices
- ❖ Use electrostatic shielding
- ❖ Use proper endings

Integrated Resistors

❖ Issue to remember

- ★ Integrated resistors and features
- ★ Resistor endings
- ★ Make bigger resistors integer multiples of the unit resistor
- ★ Finger two or more resistors for matching
- ★ Do not snake a resistor; use metal to make turns
- ★ Well under the resistor to shield from interference
- ★ Substrate bias around the resistor